

Tabela orientativa de esquemas de ligações

Motores Monofásicos

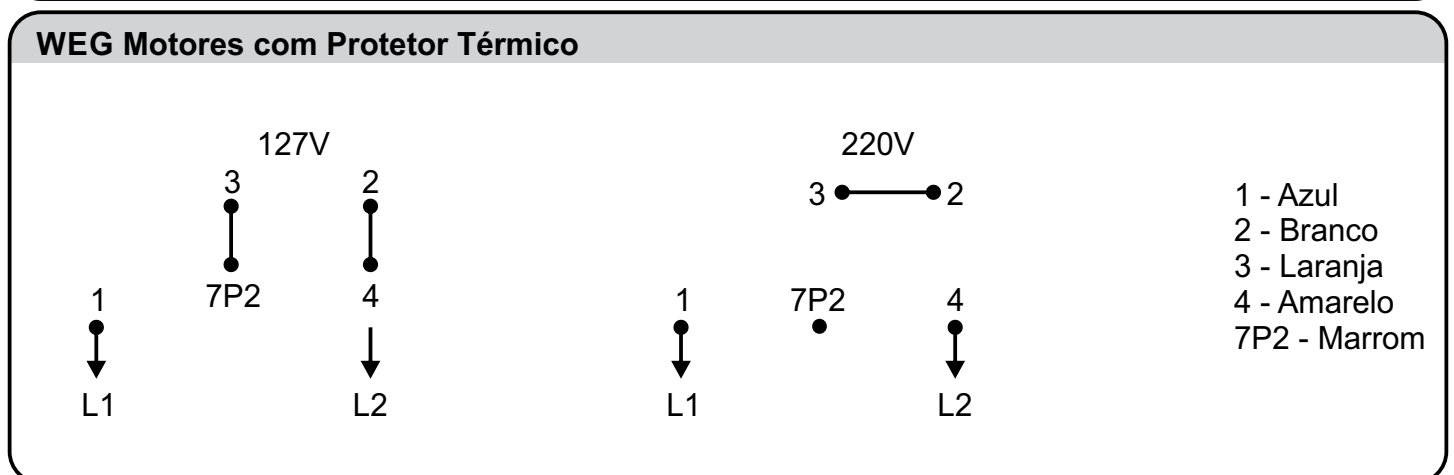
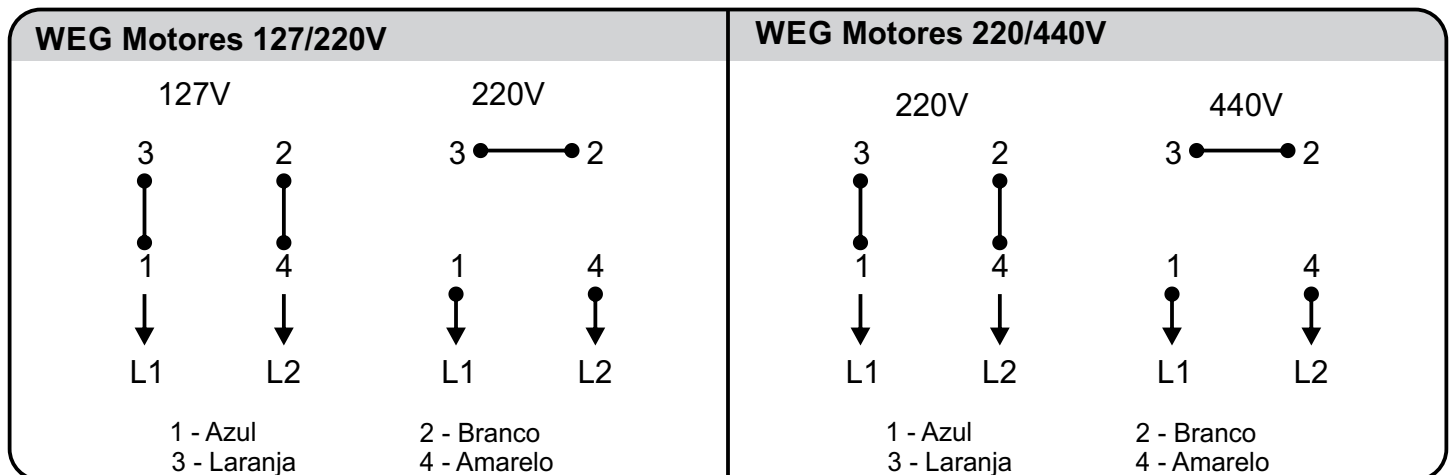
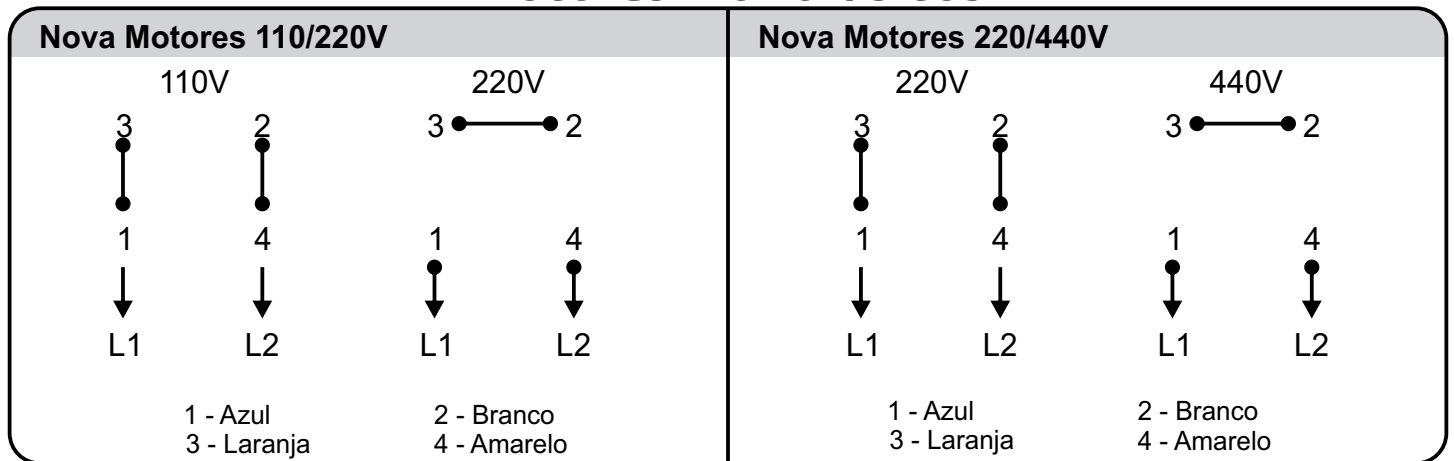

Tabelas orientativas. Em caso de dúvidas, consulte o fabricante.

Tabela orientativa de esquemas de ligações

Motores Monofásicos

XKm, XKSm

Laranja / Branco do capacitor



Azul claro / Marrom

127V

Branco



Branco do capacitor / Amarelo

Azul



Azul escuro / Preto

Obs. Os fios Azul escuro e Marrom podem estar invertidos na parte de baixo.

220V

Laranja / Branco do capacitor



Azul claro / Marrom

Branco



Branco do capacitor / Amarelo

Azul



Azul escuro / Preto

Obs. Os fios Azul escuro e Marrom podem estar invertidos na parte de baixo.

Vista: Olhando a bomba com o recalque e a sucção a esquerda, capacitor acima da ligação.

XCm, 2XCm, XHSm

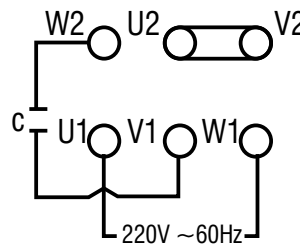
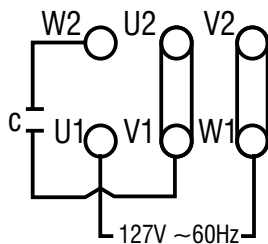

HSIS



L1



L2

ESPA

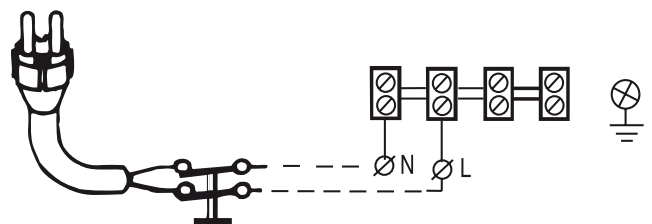

DAB - Jetcom

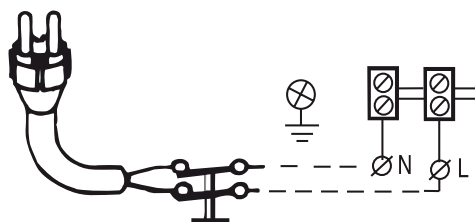

Tabelas orientativas. Em caso de dúvidas, consulte o fabricante.

Motores Monofásicos



Tabela orientativa de esquemas de ligações

Motores Trifásicos

XKT

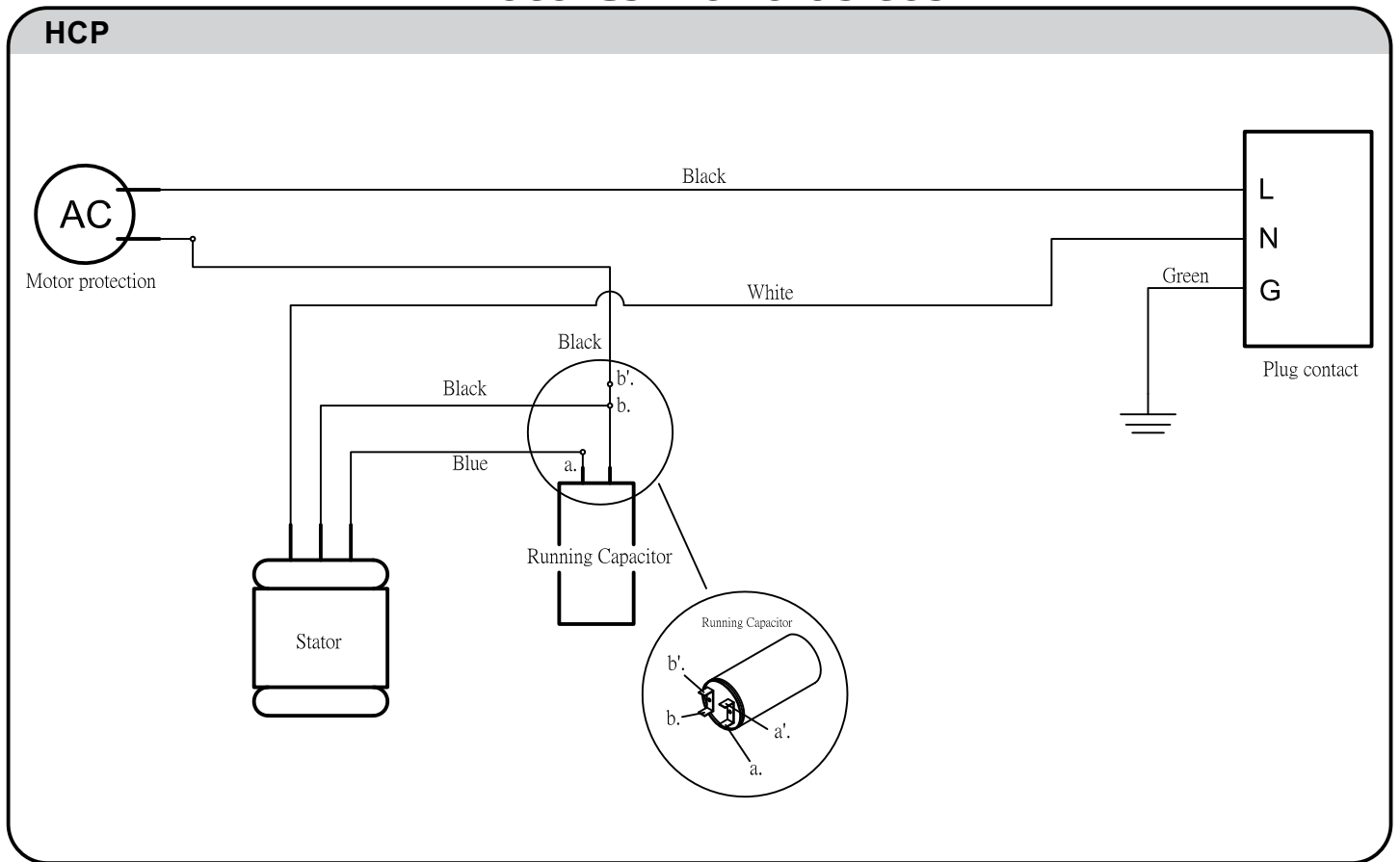
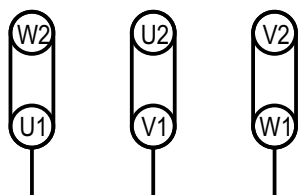

220V - 60Hz

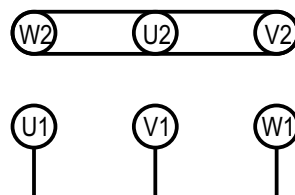

380/440V - 60Hz

12 cabos

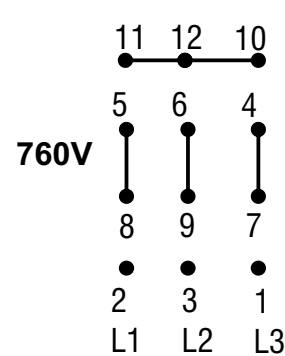
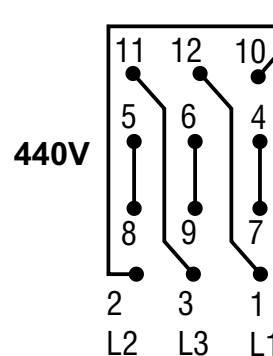
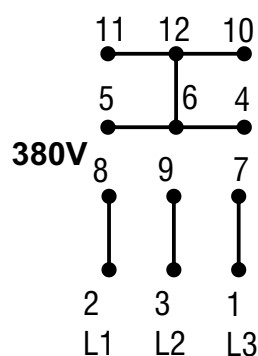
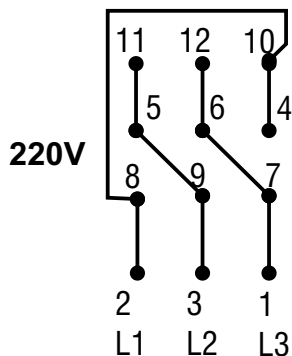

6 cabos

Motor
220/380V

220V

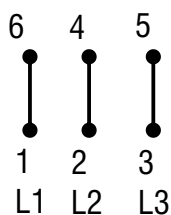

380V

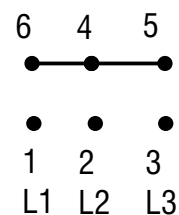

Motor
380/660V

380V

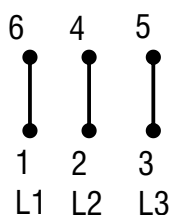

660V

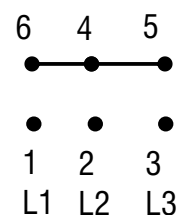

Motor
440/760V

440V

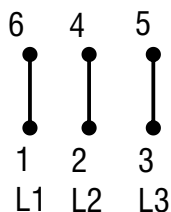

760V

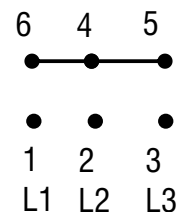

Tabelas orientativas. Em caso de dúvidas, consulte o fabricante.

Tabela orientativa de esquemas de ligações

Motores Trifásicos

HOMA 12 cabos

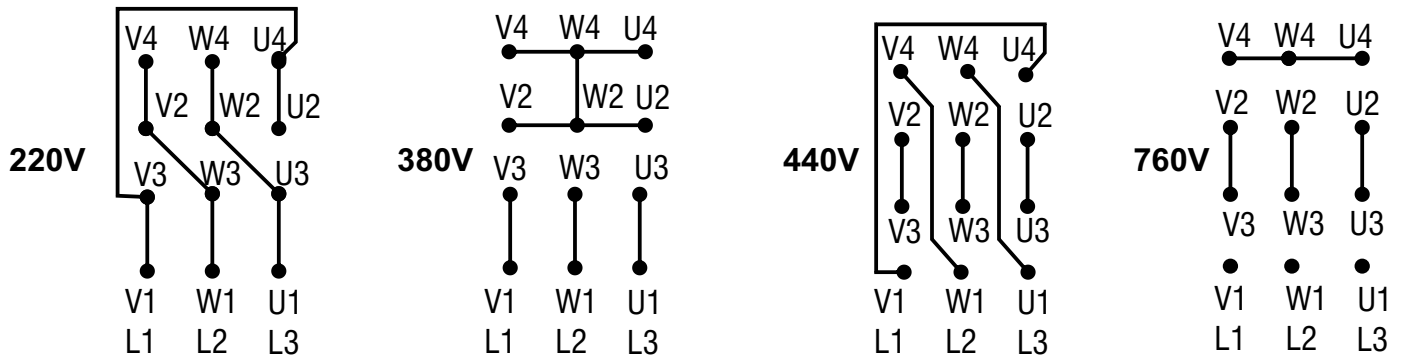

HOMA 6 cabos

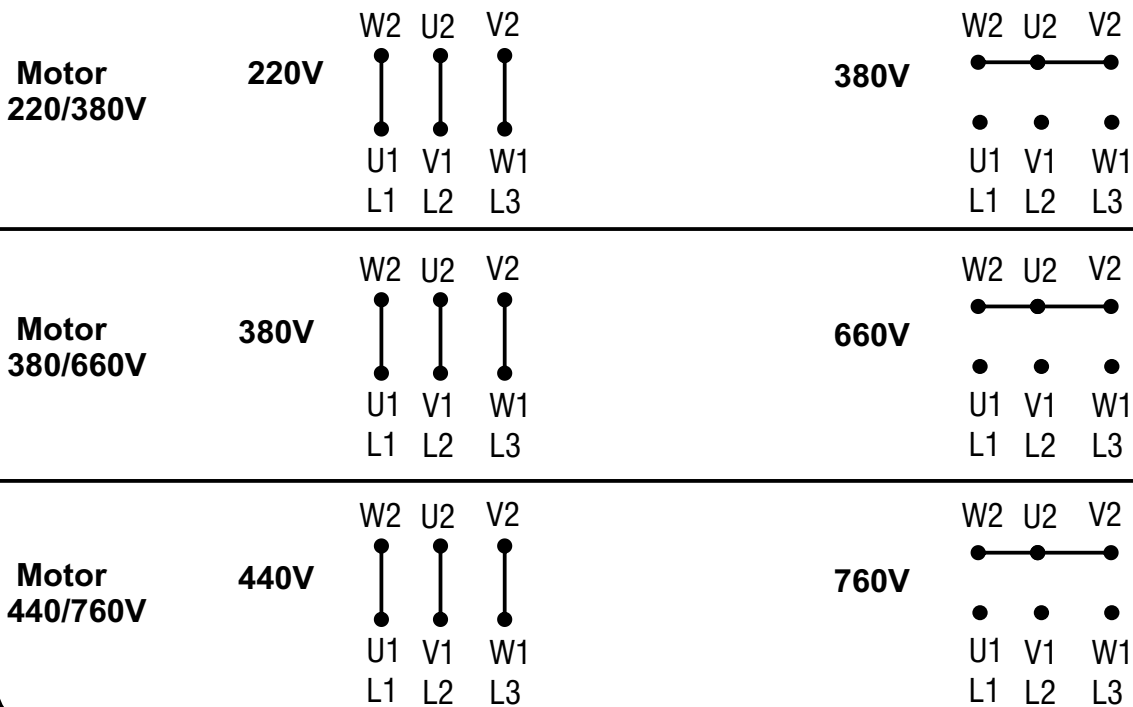

HCP

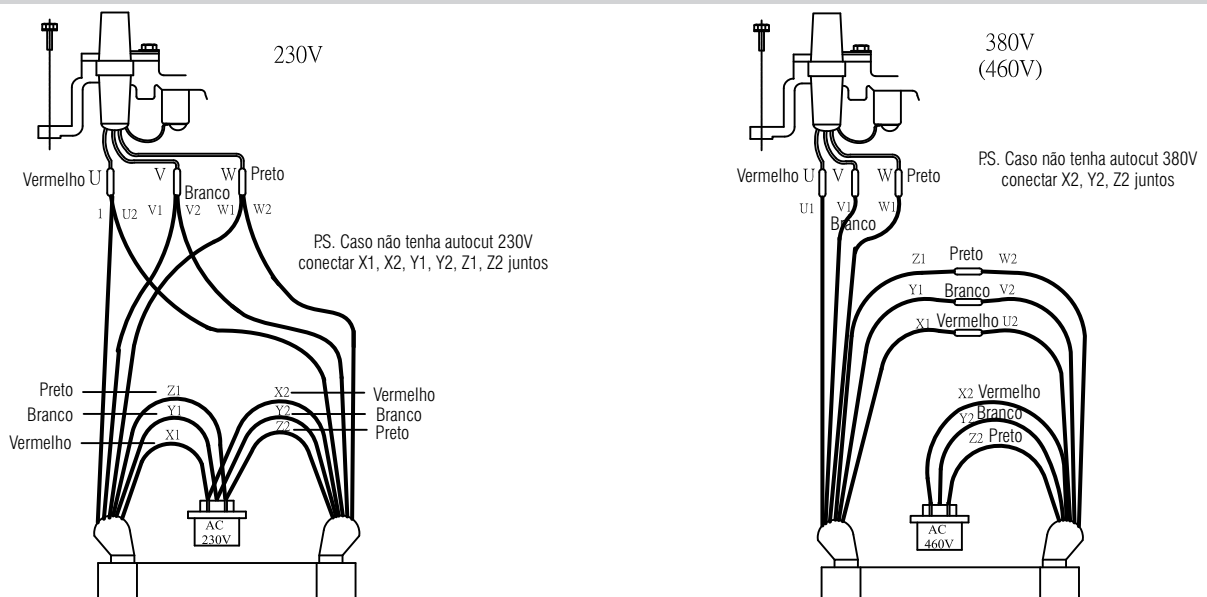

Tabelas orientativas. Em caso de dúvidas, consulte o fabricante.

Motores FBS-NG e FBS-JAC-NG

BOMBAS MONOFÁSICAS

127V

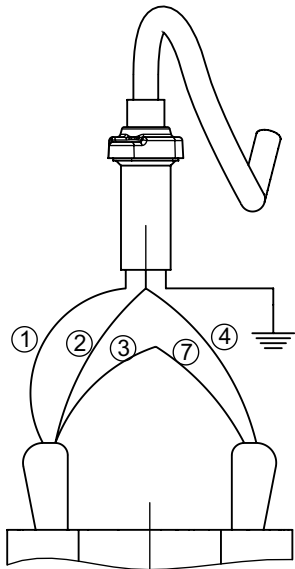

220V

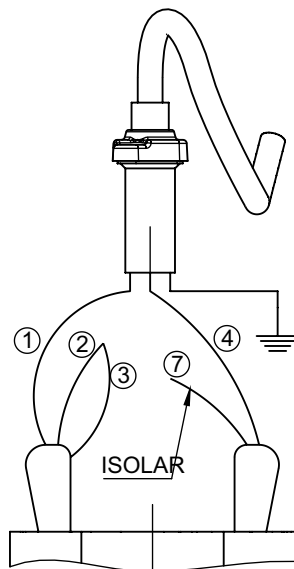

BOMBAS TRIFÁSICAS
COM PROTETOR TÉRMICO

220V

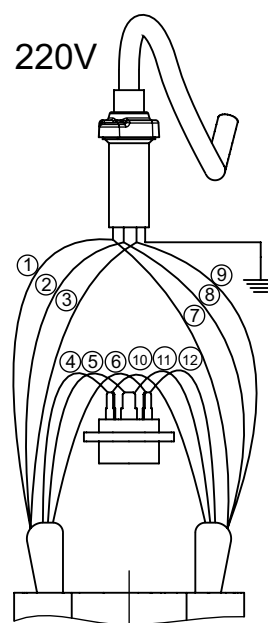

380V
440V

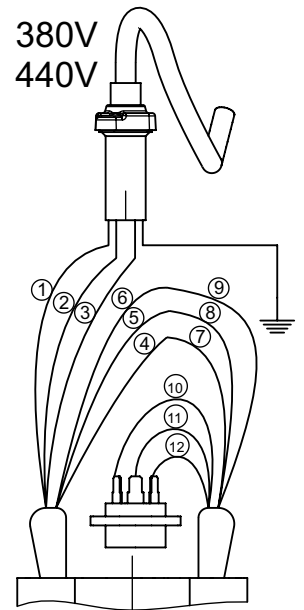

BOMBAS MONOFÁSICAS
COM CHAVE BÓIA

127V

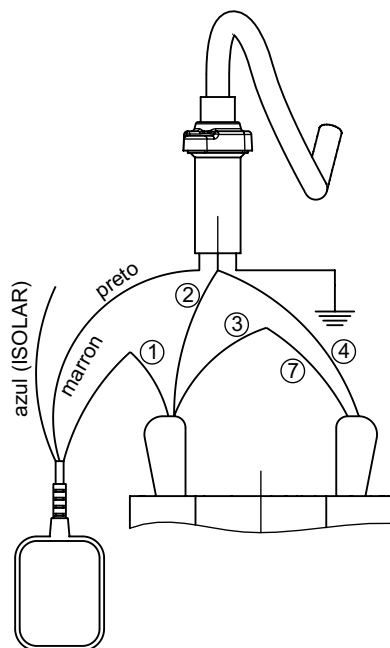

220V

